

KIT ADDUZIONE INTERNA (OPZIONALE)
 KIT FOR INTERNAL COOLANT (OPTIONAL)
 KIT FUER INTERNE KUEHLMITTELZUFUHR (OPTIONAL)
 Ø50 cod. KIT1003002

SOLO GUARNIZIONE (OPZIONALE)
 ONLY SEAL (OPTIONAL)
 NUR DICHTUNG (OPTIONAL)
 cod. 0520013

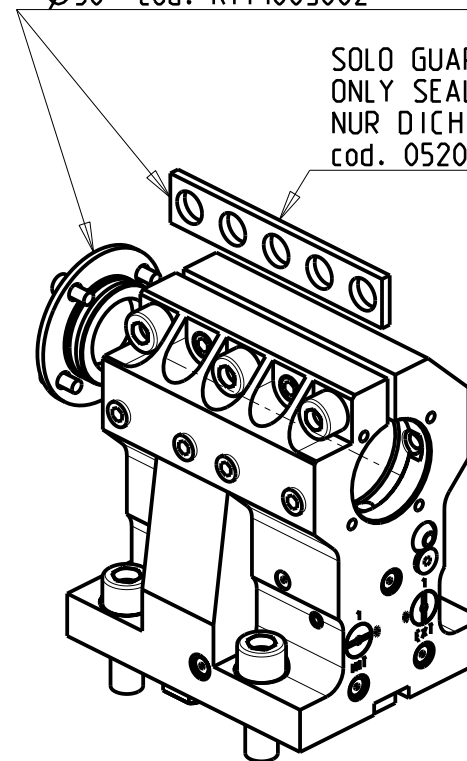

PER BOCCOLE DI RIDUZIONE VEDI PAG. TBL150-1-00
 FOR REDUCING BUSHINGS SEE PAGE TBL150-1-00
 FÜR REDUZIERBUCHSE SIEHE SEITE TBL150-1-00

Cod. MT	N°Utensili N°Tools N°Werkzeuge	Reversibile lato mandrino/contromandrino Reversible sub/main spindle side Umkehrbare Spindel-seite/ Gegenspindel-seite	Lubrificazione int. opzionale Coolant through optional Innenkuehlung Optional	Lubrificazione est. Ext. coolant Aussenkuehlung	Misure Dimensions Masse	D
DW00205000	1	X	X	X	mm	50

HYUNDAI-WIA (KIA)

SKT200TTM/TTMS/TTSY - LM2000TTM/TTMS/TTSY - L2000/2600/3000Y/SY - L300M/LM/MS/LMS
 SKT250TTM/TTMS/TTSY - LM2500TTM/TTMS/TTSY - SKT250M/LM/MS - SKT300M/LM/MS - LV450RM/LM - HD2600/3100 (BMT65)

PORTAUTENSILE ASSIALE PER BARENO Ø50mm H=100mm

Axial single boring bar holder Ø50mm H=100mm

Axial Bohrhälter Ø50mm H=100mm

Subject to change without notice.

M.T. srl

Via Casino Albini 480
 Tel. 0541/956034-957884
 Fax 0541/956341

47842 S. GIOVANNI IN M. (RN)
 e-mail: mtma@mtmarchetti.com
 http://www.mtmarchetti.com



KIA620-3-20