

KIT ADDUZIONE INTERNA (OPZIONALE)
 KIT FOR INTERNAL COOLANT (OPTIONAL)
 KIT FUER INTERNE KUEHLMITTELZUFUHR (OPTIONAL)
 Ø40 cod. KIT1003003
 Ø1 1/2" cod. KIT1003004

SOLO GUARNIZIONE (OPZIONALE)
 ONLY SEAL (OPTIONAL)
 NUR DICHTUNG (OPTIONAL)
 cod. 0520013

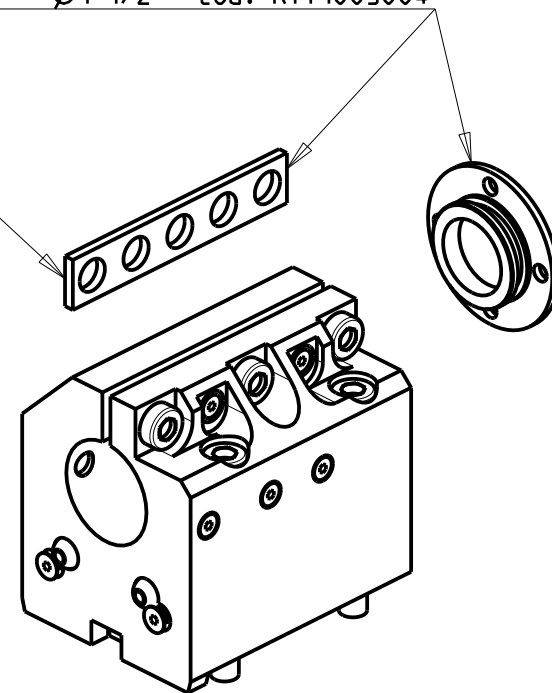

PER BOCCOLE DI RIDUZIONE VEDI PAG. TBL150-1-00
 FOR REDUCING BUSHINGS SEE PAGE TBL150-1-00
 FÜR REDUZIERBUCHSE SIEHE SEITE TBL150-1-00

Cod. MT	N°Utensili N°Tools N°Werkzeuge	Reversibile lato mandrino/controlmandrino Reversible sub/main spindle side Umkehrbare Spindel-seite/ Gegenspindel-seite	Lubrificazione int. opzionale Coolant through optional Innenkühlung Optional	Lubrificazione est. Ext. coolant Aussenkühlung	Misure Dimensions Masse	D
0814000	1	X	X	X	mm	40
0813810	1	X	X	X	Inch	1 1/2"

GOODWAY

MOD: GTX2000/2600 16ST. - GTZ2000/2600 16ST.

PORTAUTENSILE ASSIALE PER BARENO Ø40mm / Ø1 1/2" H=60mm

Axial single boring bar holder Ø40mm / Ø1 1/2" H=60mm

Axial Bohrhälter Ø40mm / Ø1 1/2" H=60mm

Subject to change without notice.

M.T. srl

Via Casino Albini 480
 Tel. 0541/956034-957884
 Fax 0541/956341

47842 S. GIOVANNI IN M. (RN)
 e-mail: mtma@mtmarchetti.com
 http://www.mtmarchetti.com



GDW 630-3-20

09/2025